

ZSELICI TÁJVÉDELMI KÖRZET

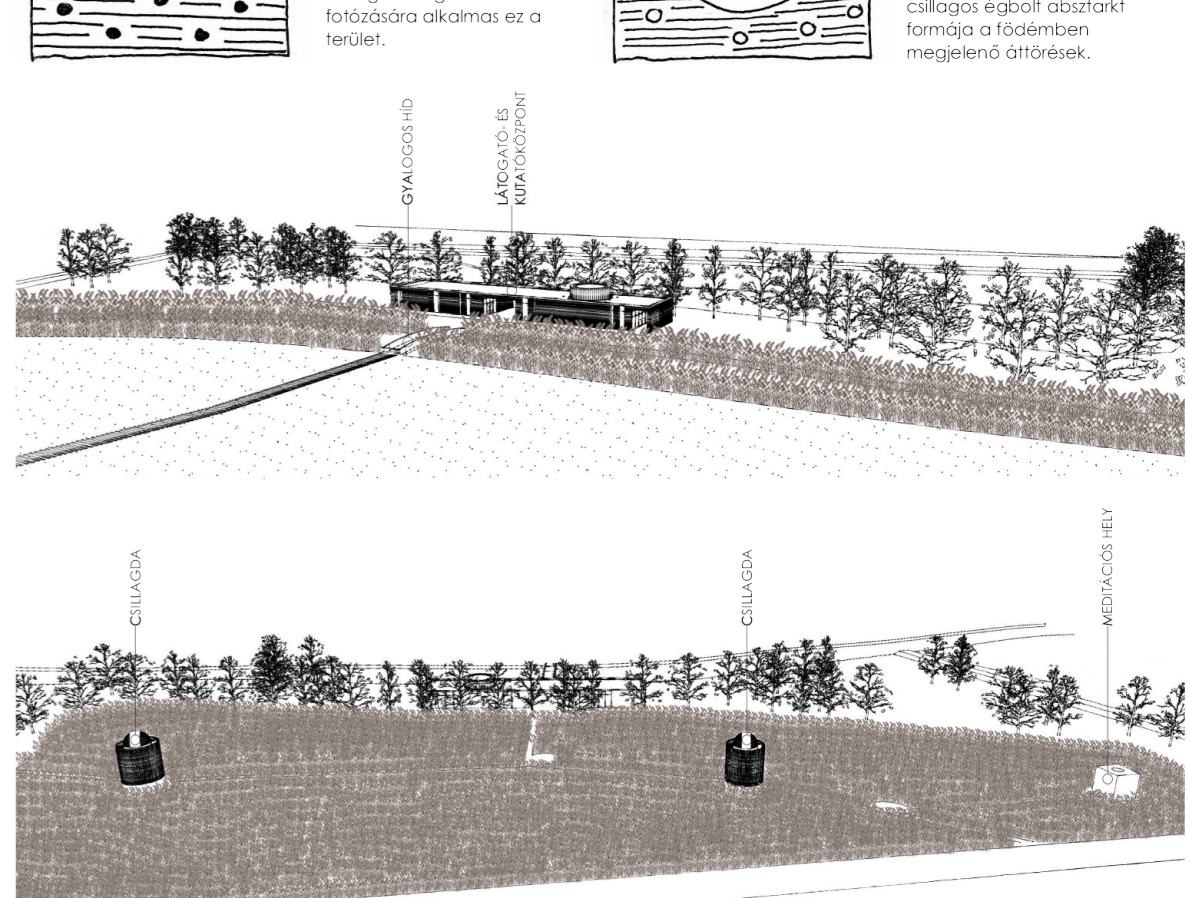

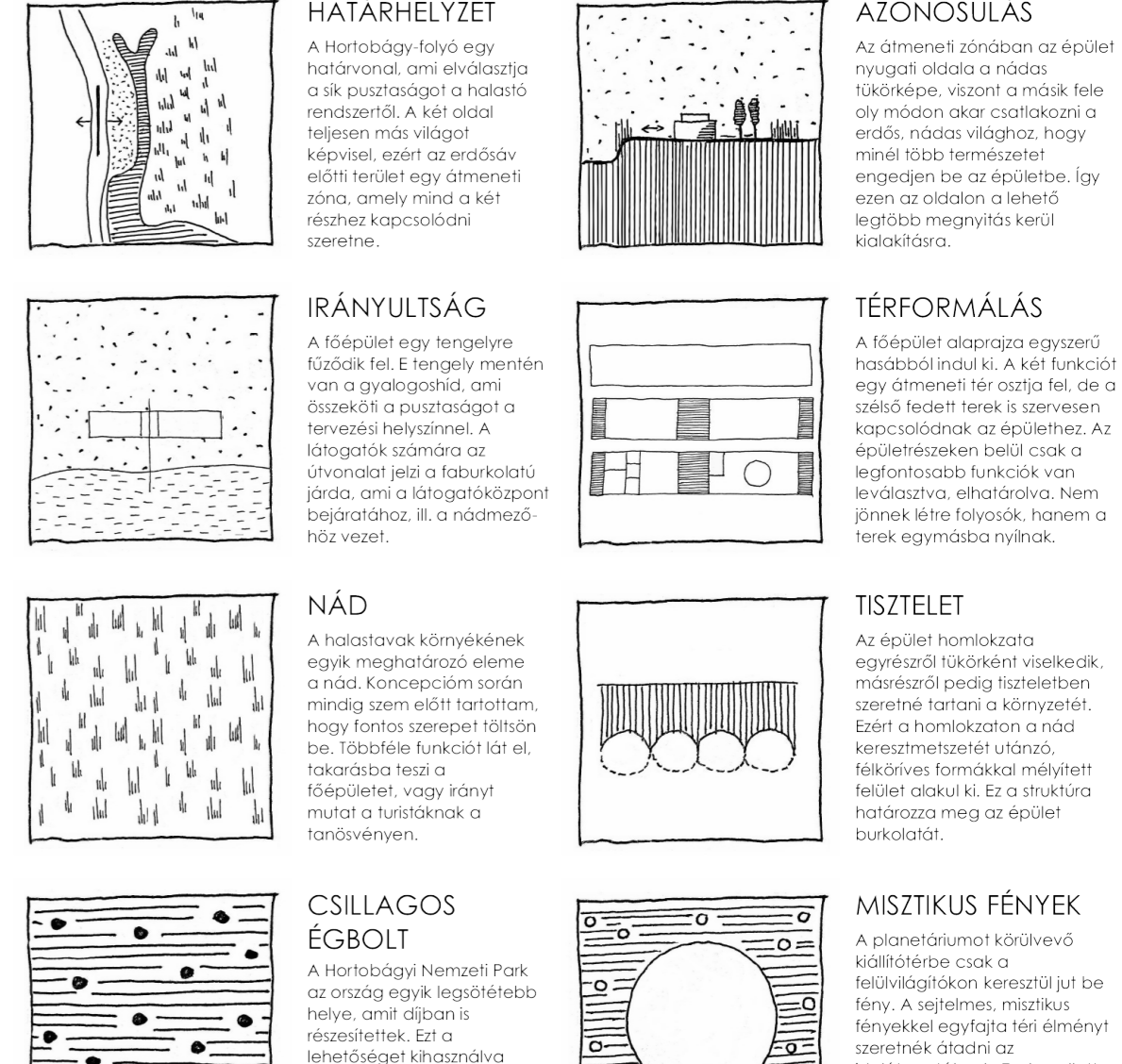
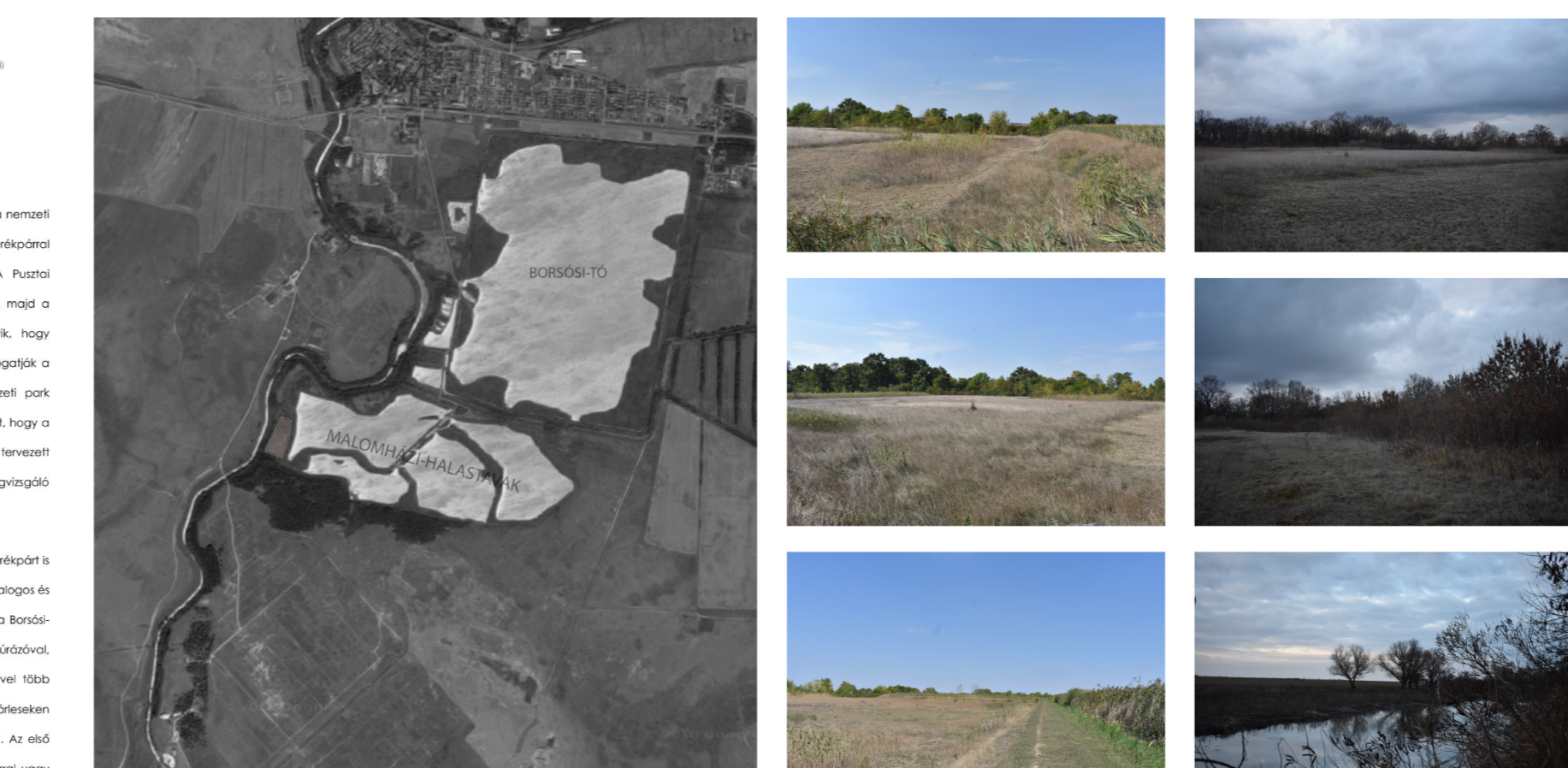
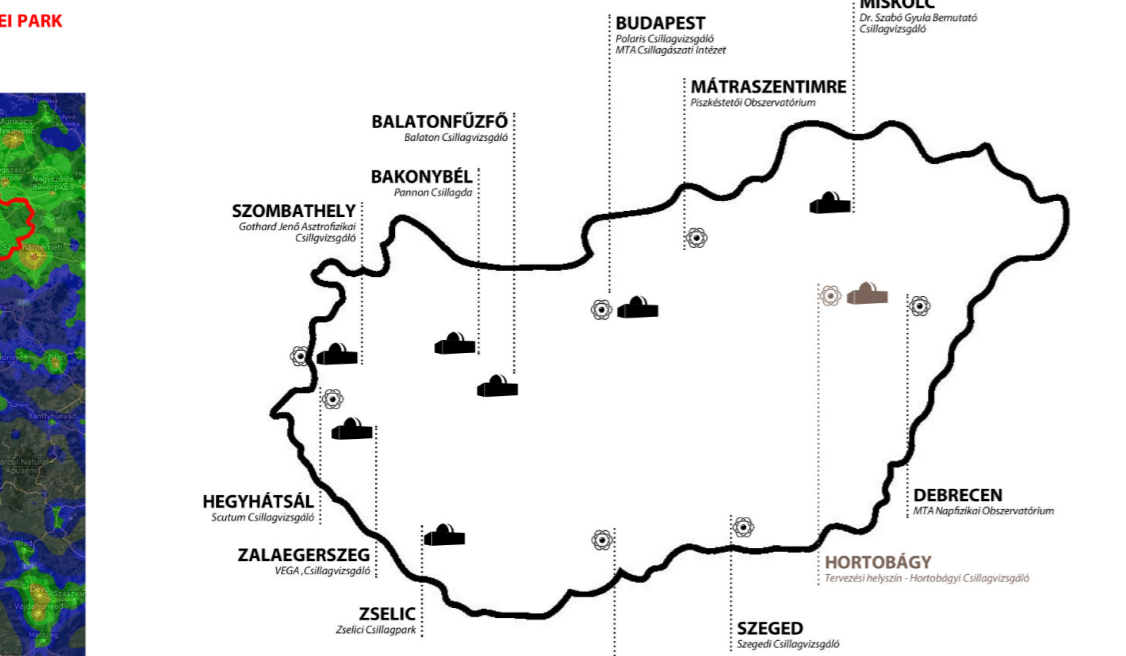

- JELMAGYARÁZAT**
- 1 ASZFALTOZOTT ÚT
 - 2 GYALOGÓS, FA SZERKEZETŰ HÍD
 - 3 LÁTÓGATÓ- ÉS KUTATÓKÖZPONT
 - 4 ESZLELŐ TERASZ
 - 5 SÁTORHELYEK
 - 6 TÖLTÉS / FÖLDÚT
 - 7 "NAGY GÖNCÖL" TÁNÖSVÉNY BEJÁRATA
 - 8 MEDITÁCIÓS HELY
 - 9 TÁNÖSVÉNY TÁJÉKOZTATÓ PONT
 - 10 NAPTÁVCSÓ
 - 11 NAPÓRA
 - 12 APOKROMATIKUS LENCSES TÁVCSÓ
 - 13 TÁNÖSVÉNY FOLYTATÁSA AZ ERDŐBEN
 - 14 NÁDMEZŐ
 - 15 MALOMHÁZI HALASTAVAK
 - 16 HORTOBÁGYI-FOLYÓ

Bérelési előírások

építési övezet	M05 - Orsz. öko. föld. dörnyös öv. mezőgazdasági öv.
beépíthető legkisebb telekterület 5 ha	38
maximális beépíthetőség	3%
maximális épületmagasság	9,00 m

Bérelési adatok

helyi azonosító	01551
helyi azonosító	20740 m ²
telek mérete	510,5 m ² (2,44%)
beépíthetőség	472,6 m ²
szelvény aránya	19955,9 m ²
épületmagasság	4,90 m

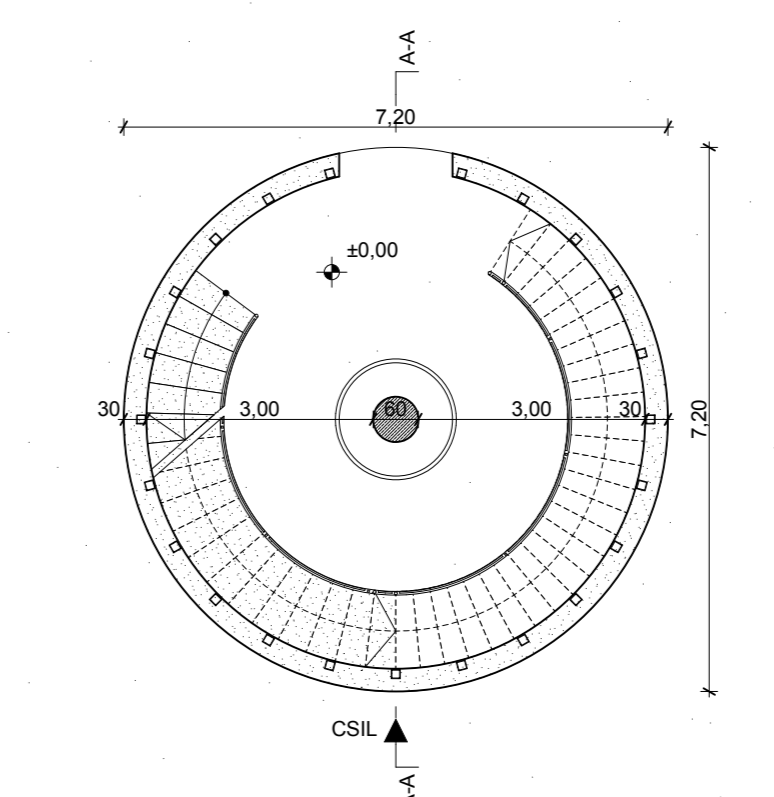

CSILLAGDA - FSZ ALAPRAJZ 1:100

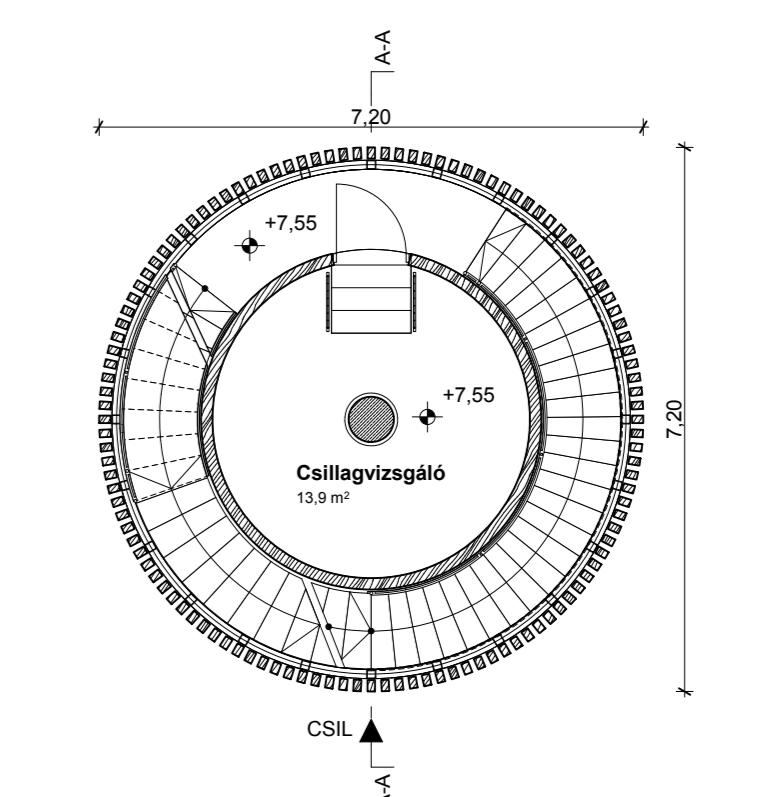

CSILLAGDA - 1. EM ALAPRAJZ 1:100

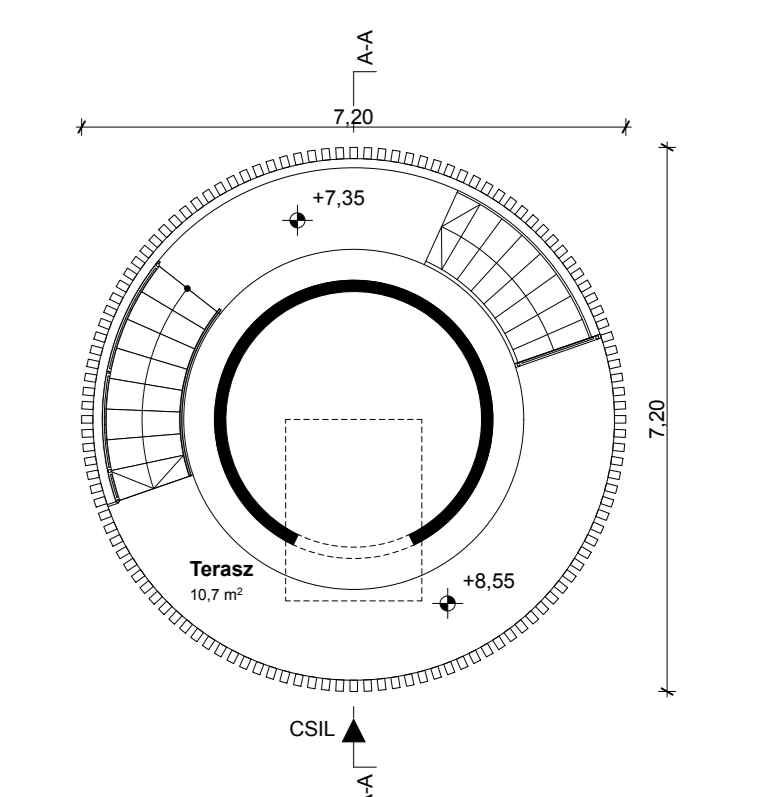

CSILLAGDA - 2. EM ALAPRAJZ 1:100

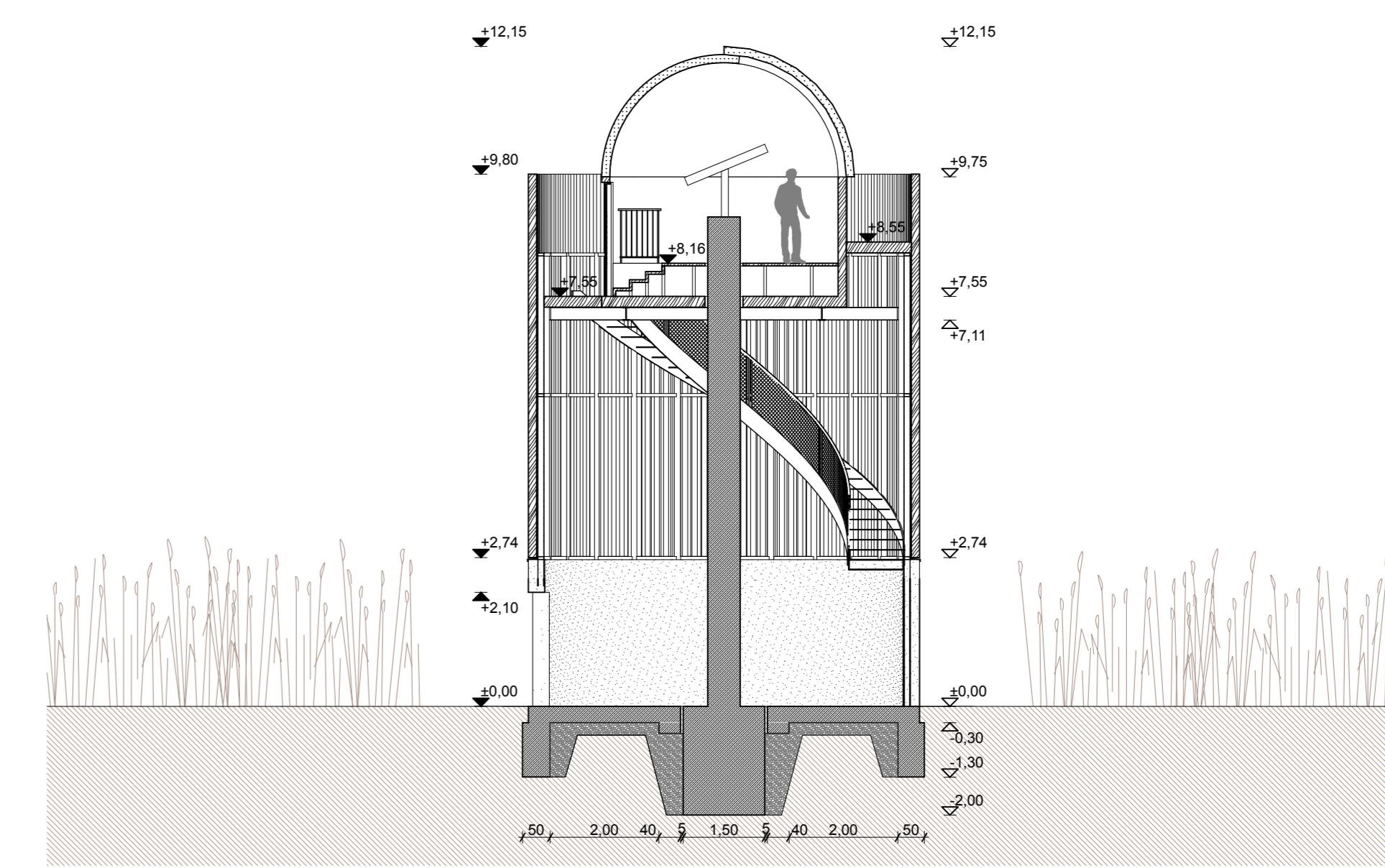

CSILLAGDA - METSZET 1:100

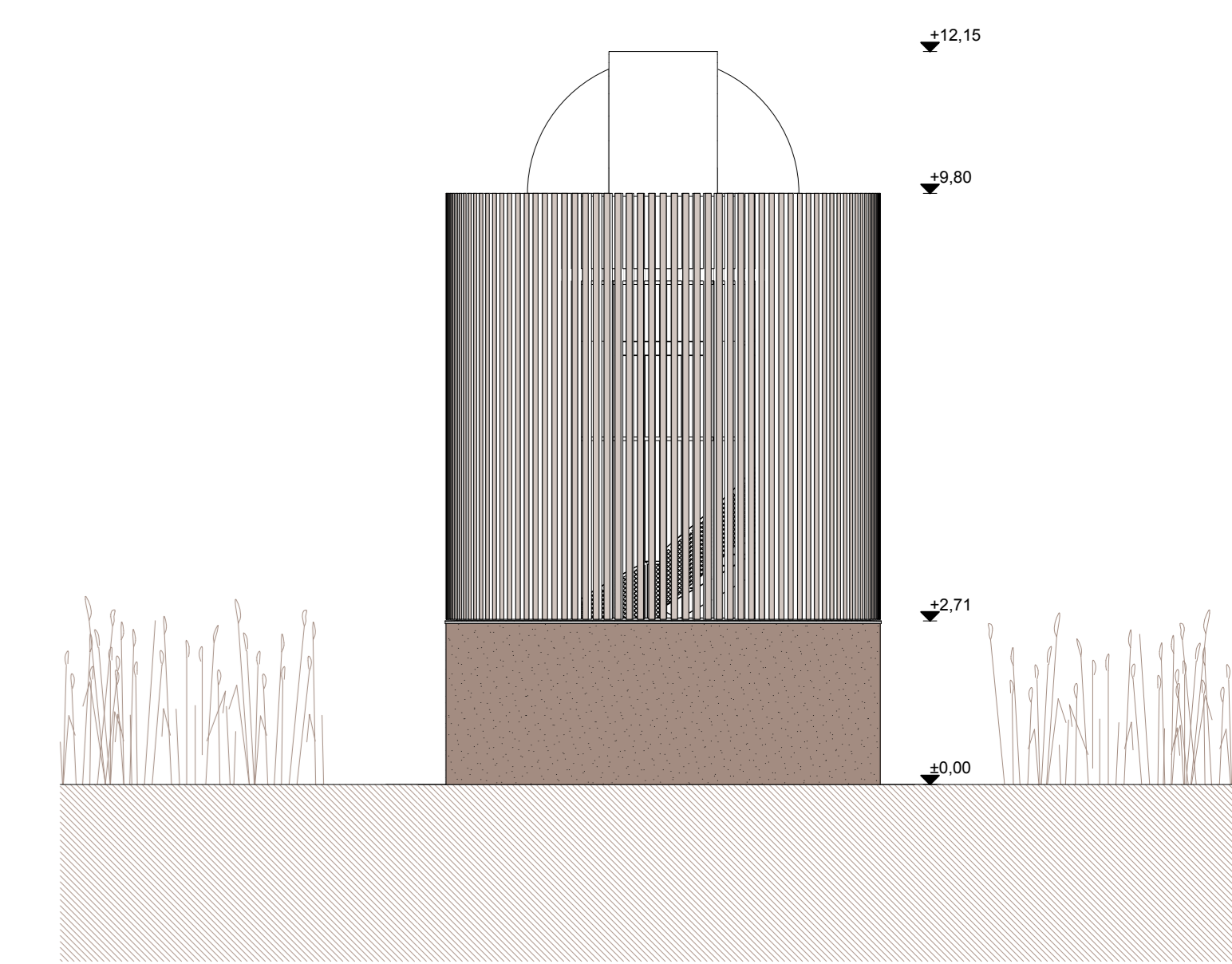

CSILLAGDA - HOMLOKZAT 1:100

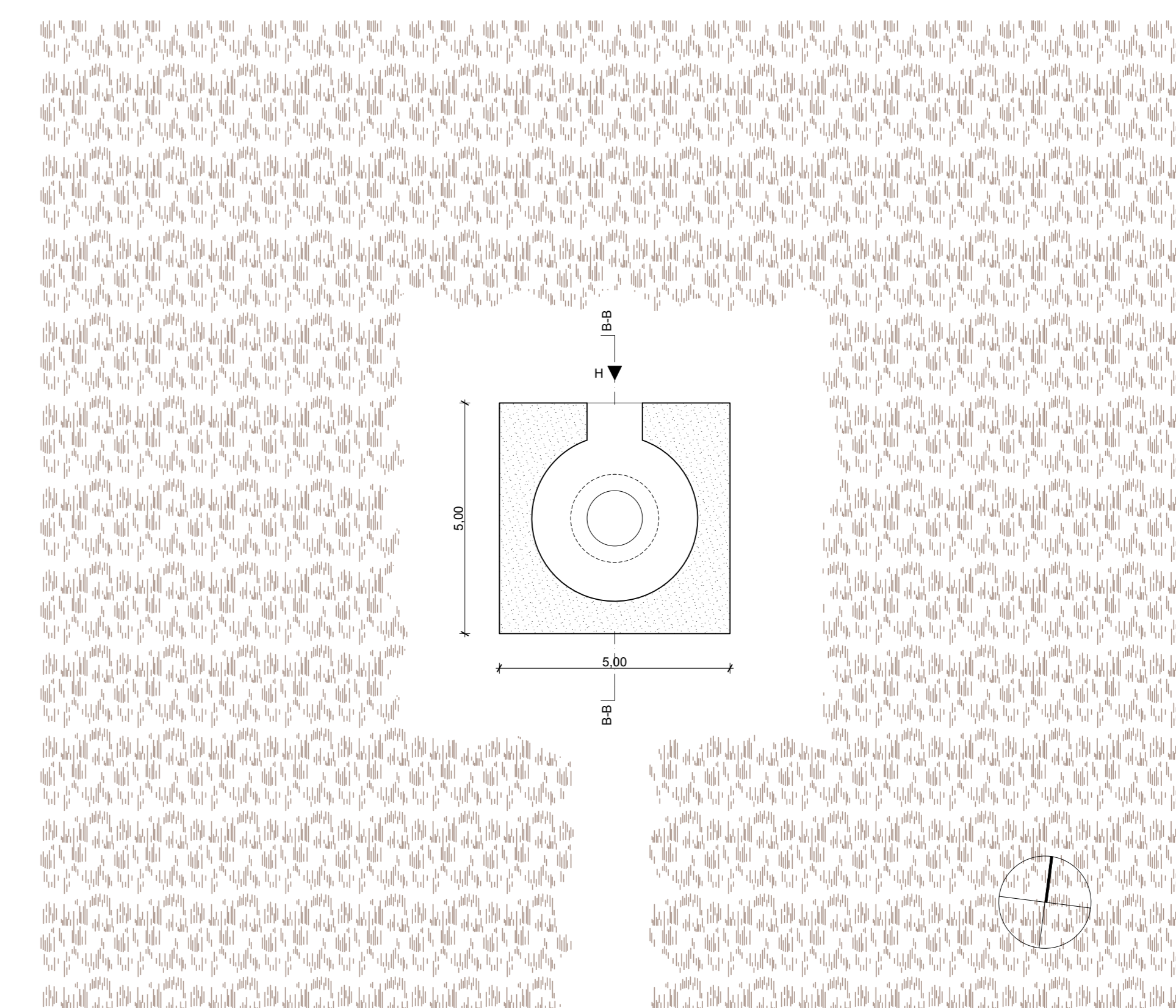

MEDITÁCIÓS HELY - ALAPRAJZ 1:100

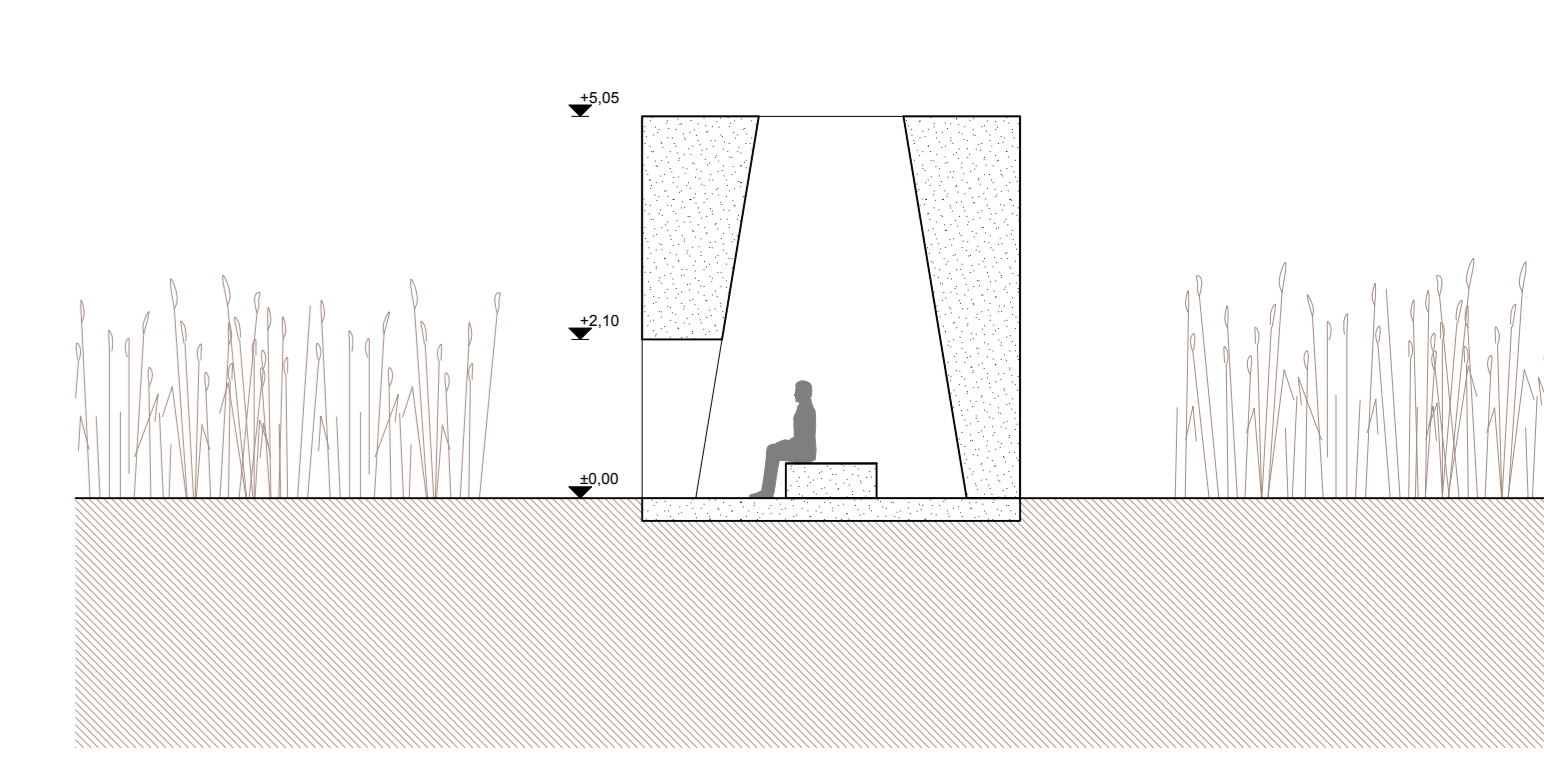

MEDITÁCIÓS HELY - METSZET 1:100

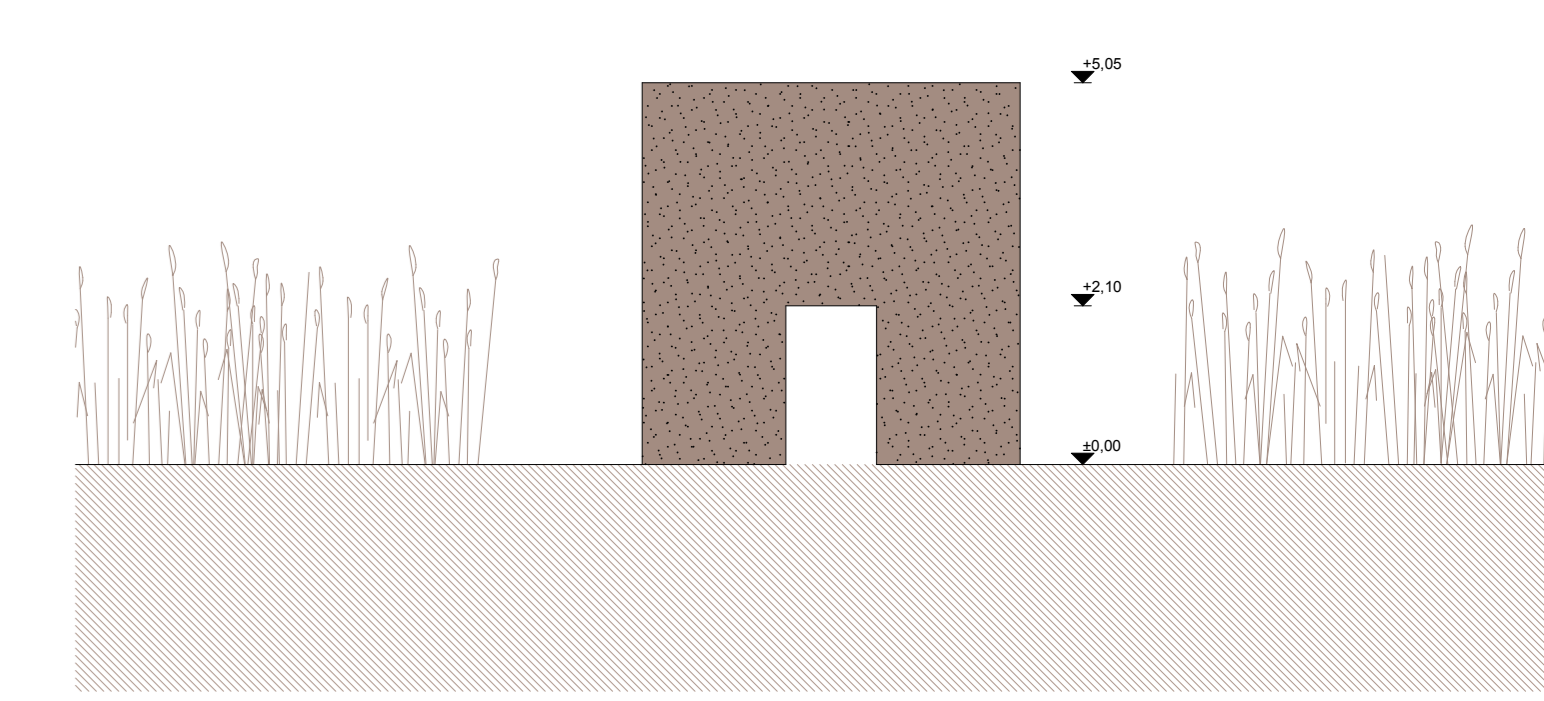

MEDITÁCIÓS HELY - HOMLOKZAT 1:100

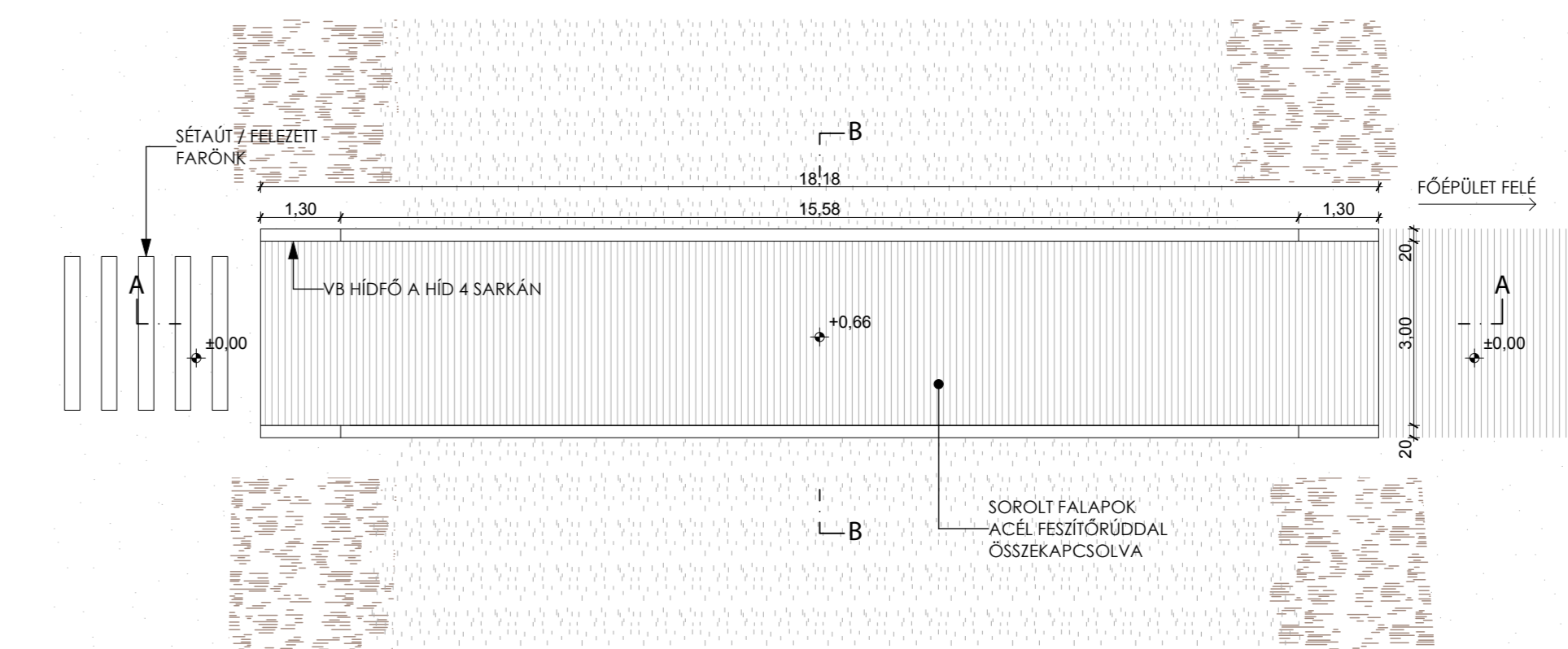

GYALOGÓS HÍD - ALAPRAJZ 1:100

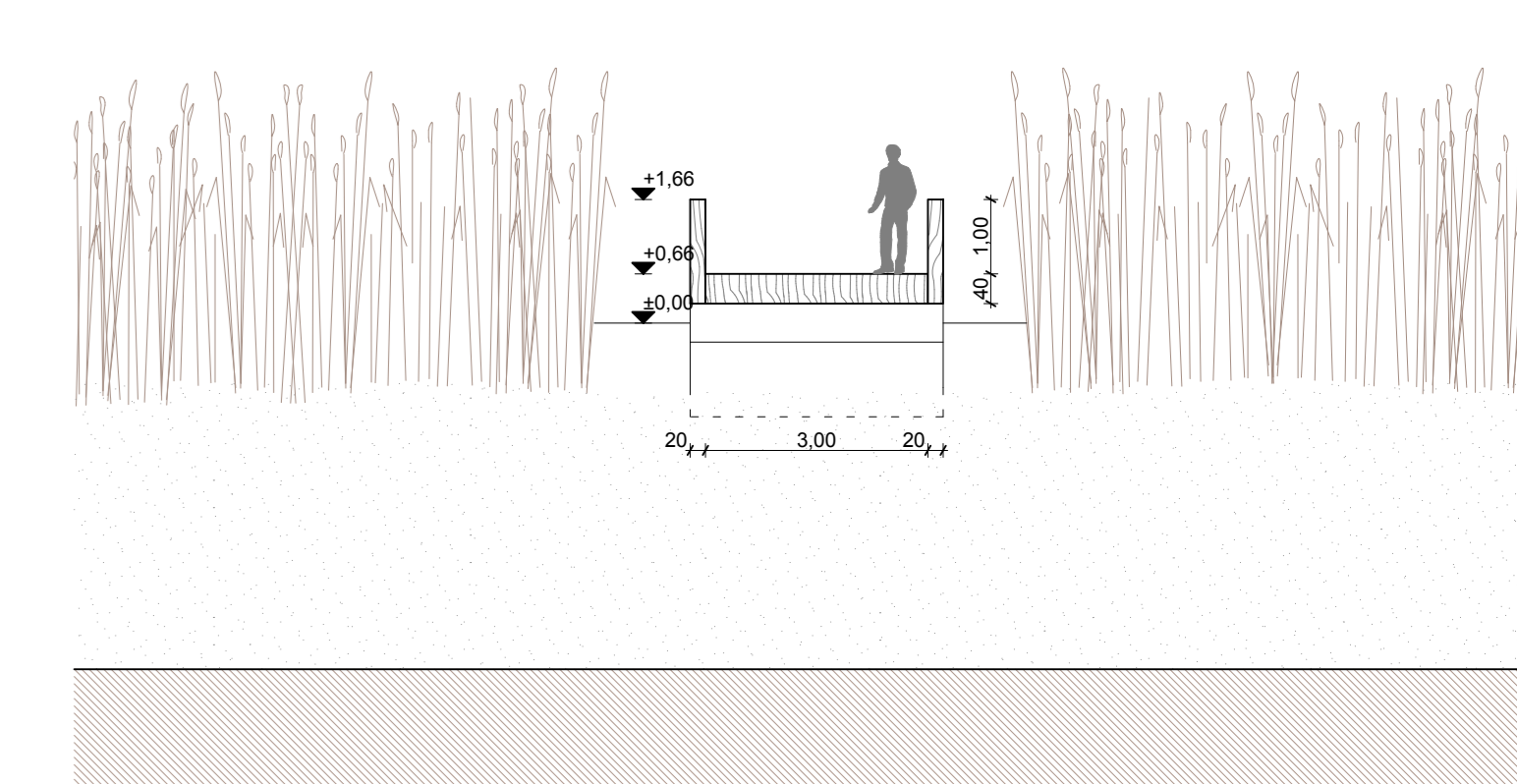

GYALOGÓS HÍD - METSZET 1:100

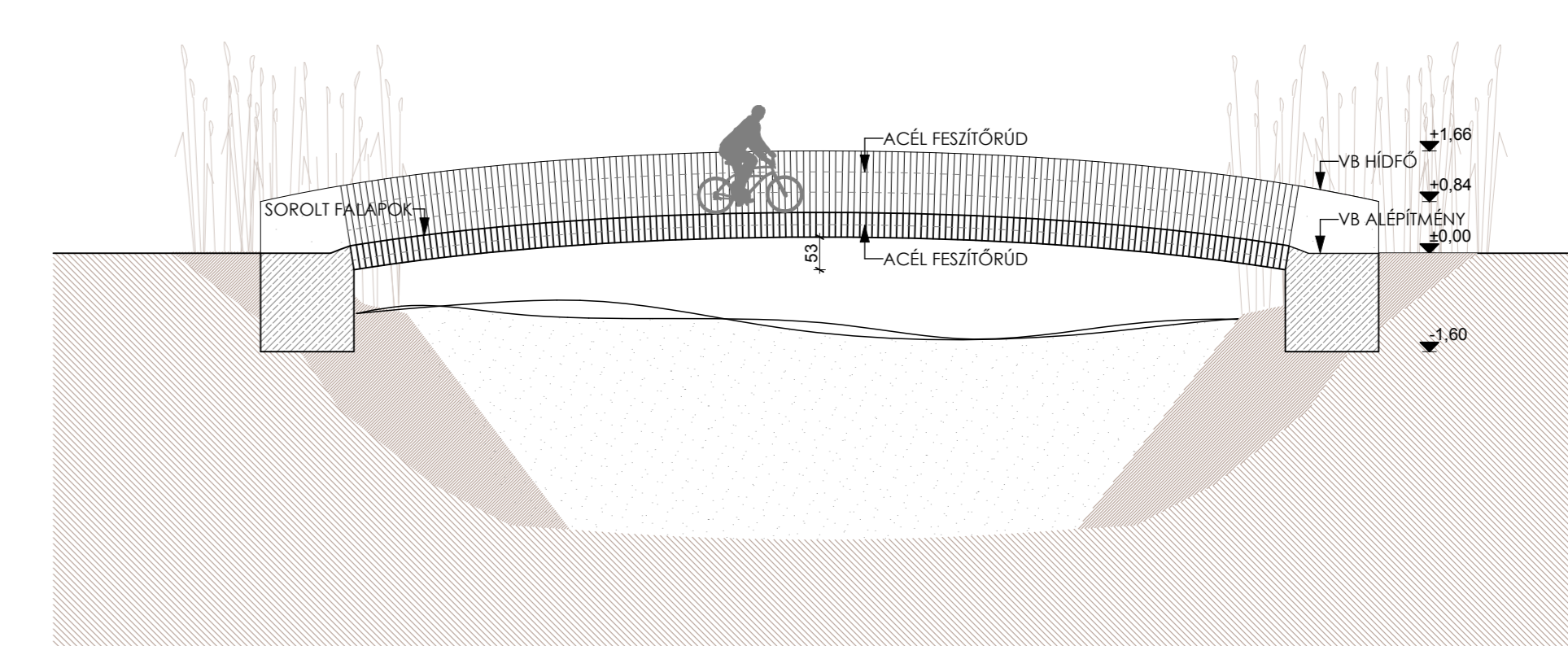

GYALOGÓS HÍD - NÉZET 1:100





FÖLDSZINTI ALAPRAJZ 1:100

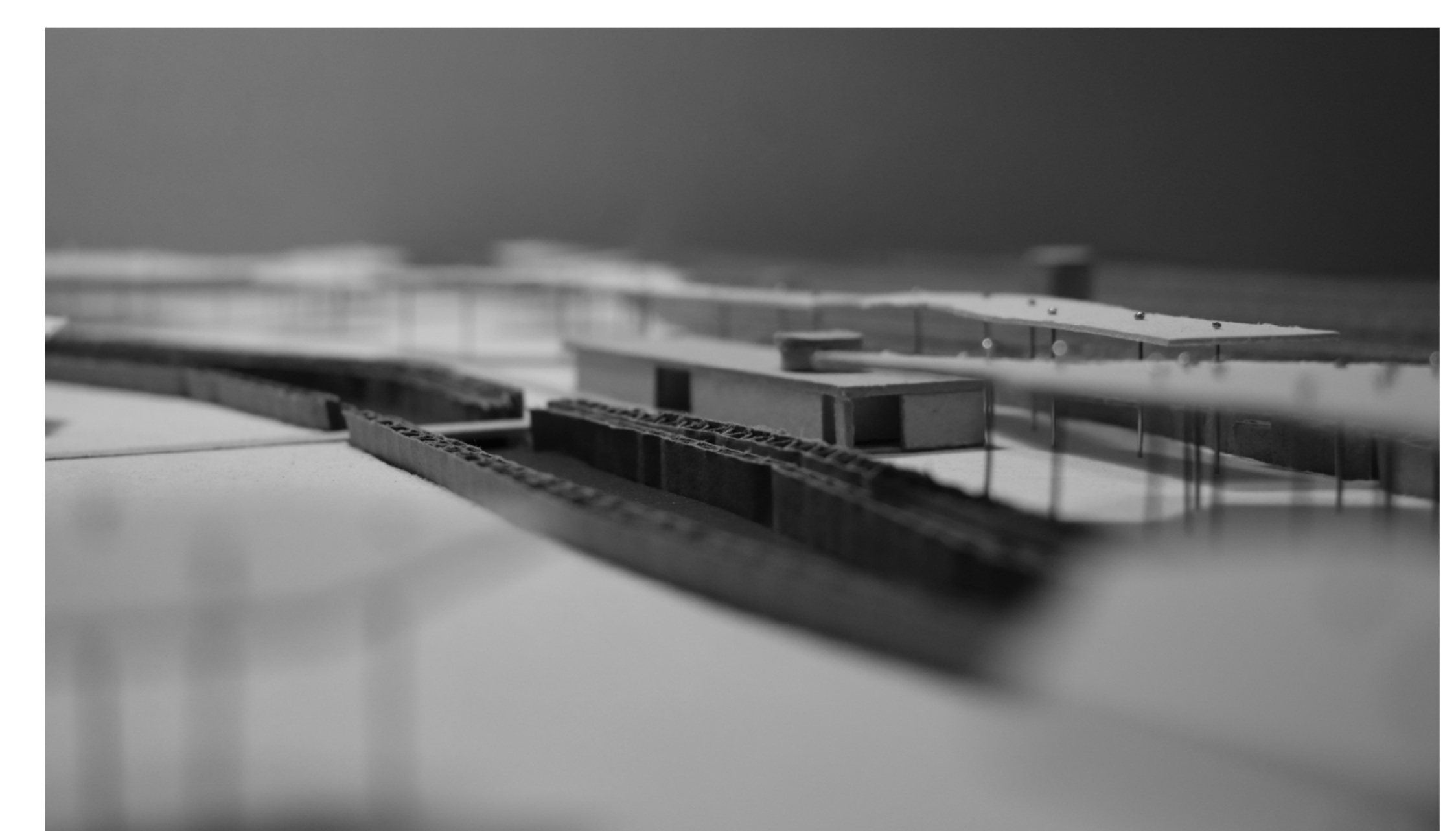



A-A METSZET 1:100

B-B METSZET 1:100

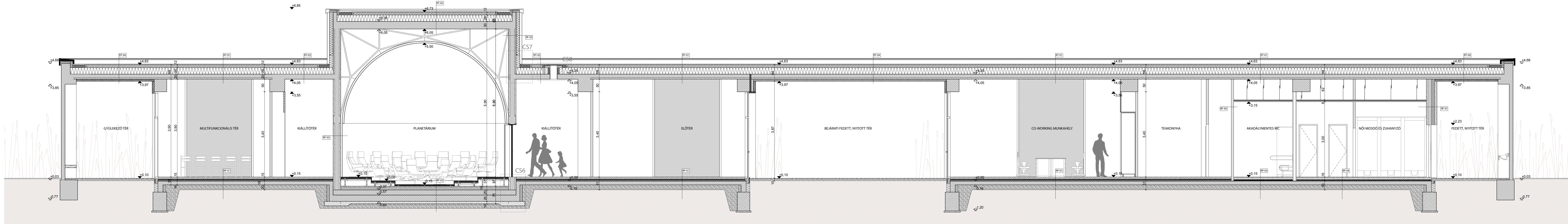
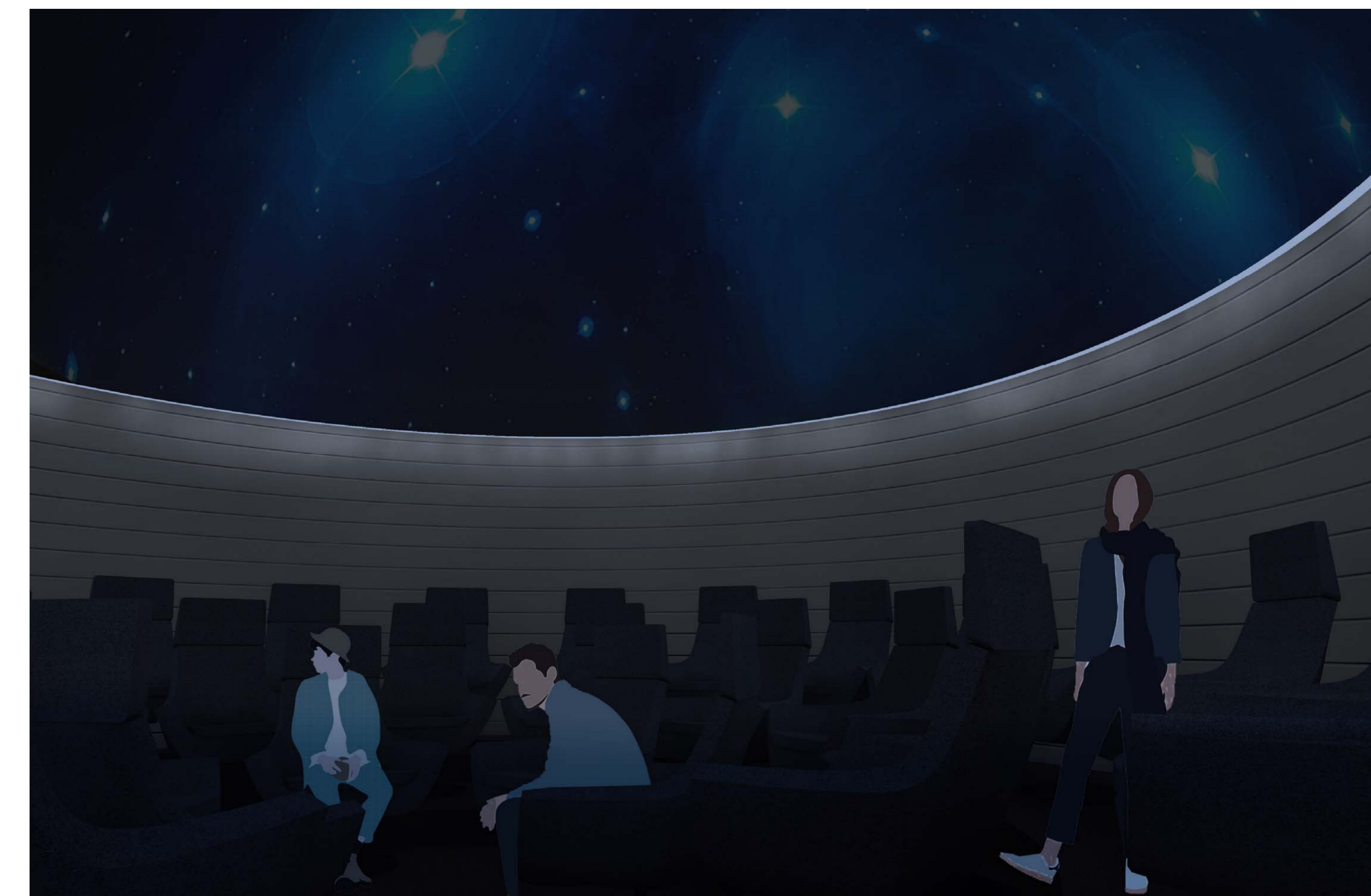

C-C METSZET 1:50

FAKASZ	FAKASZ	FAKASZ	FAKASZ	FAKASZ	FAKASZ	FAKASZ	FAKASZ	FAKASZ	FAKASZ	FAKASZ	FAKASZ	FAKASZ
RF-01 - Külső előregyártott vb falszerkezet (Planetárium) 8 cm 14 cm 14 cm 6 cm 1 ng	RF-02 - Belső előregyártott vb falszerkezet (Planetárium) 9 cm 4 cm 15 cm 1 cm 30 cm 1 ng	RF-03 - Belső előregyártott vb falszerkezet (Planetárium) 1 ng 1 ng 1 ng 1 ng 6 cm	RF-04 - Gipszkarton válaszfal (Planetárium) 1 ng 2,5 cm 2,5 cm 2,5 cm 2,5 cm 1 ng	RF-01 - Műgyanta burkolat ajtószelvényen (Planetárium) 4 mm 0,05 mm 1 ng 1 ng 1 ng 1 ng 1 ng 1 ng 1 ng 1 ng 1 ng 1 ng 1 ng 1 ng	RF-02 - Szőnyegpadló burkolat ajtószelvényen (Planetárium) 7 mm 3 mm 3 mm 1 ng 1 ng 1 ng 1 ng 1 ng 1 ng 1 ng 1 ng 1 ng 1 ng 1 ng	RF-03 - Berendezési tárgy burkolat (Mondák) 12 cm 12 cm 12 cm 12 cm 12 cm 12 cm 12 cm 12 cm 12 cm 12 cm 12 cm 12 cm 12 cm 12 cm 12 cm	RF-04 - Üzemi víz elleni zárt fal burkolat (Planetárium) 12 cm 12 cm 12 cm 12 cm 12 cm 12 cm 12 cm 12 cm 12 cm 12 cm 12 cm 12 cm 12 cm 12 cm 12 cm	RF-01 - Egyenes rétegrendű lapostető előregyártott födém (Planetárium) 12 cm 12 cm 12 cm 12 cm 12 cm 12 cm 12 cm 12 cm 12 cm 12 cm 12 cm 12 cm 12 cm 12 cm 12 cm 12 cm	RF-02 - Egyenes rétegrendű lapostető 20 cm vtg monolit födém (Planetárium) 12 cm 12 cm 12 cm 12 cm 12 cm 12 cm 12 cm 12 cm 12 cm 12 cm 12 cm 12 cm 12 cm 12 cm 12 cm 12 cm	RF-03 - Egyenes rétegrendű lapostető 30 cm vtg monolit födém (Planetárium) 12 cm 12 cm 12 cm 12 cm 12 cm 12 cm 12 cm 12 cm 12 cm 12 cm 12 cm 12 cm 12 cm 12 cm 12 cm 12 cm	RF-04 - Egyenes rétegrendű lapostető előregyártott födém (Planetárium) 12 cm 12 cm 12 cm 12 cm 12 cm 12 cm 12 cm 12 cm 12 cm 12 cm 12 cm 12 cm 12 cm 12 cm 12 cm 12 cm	

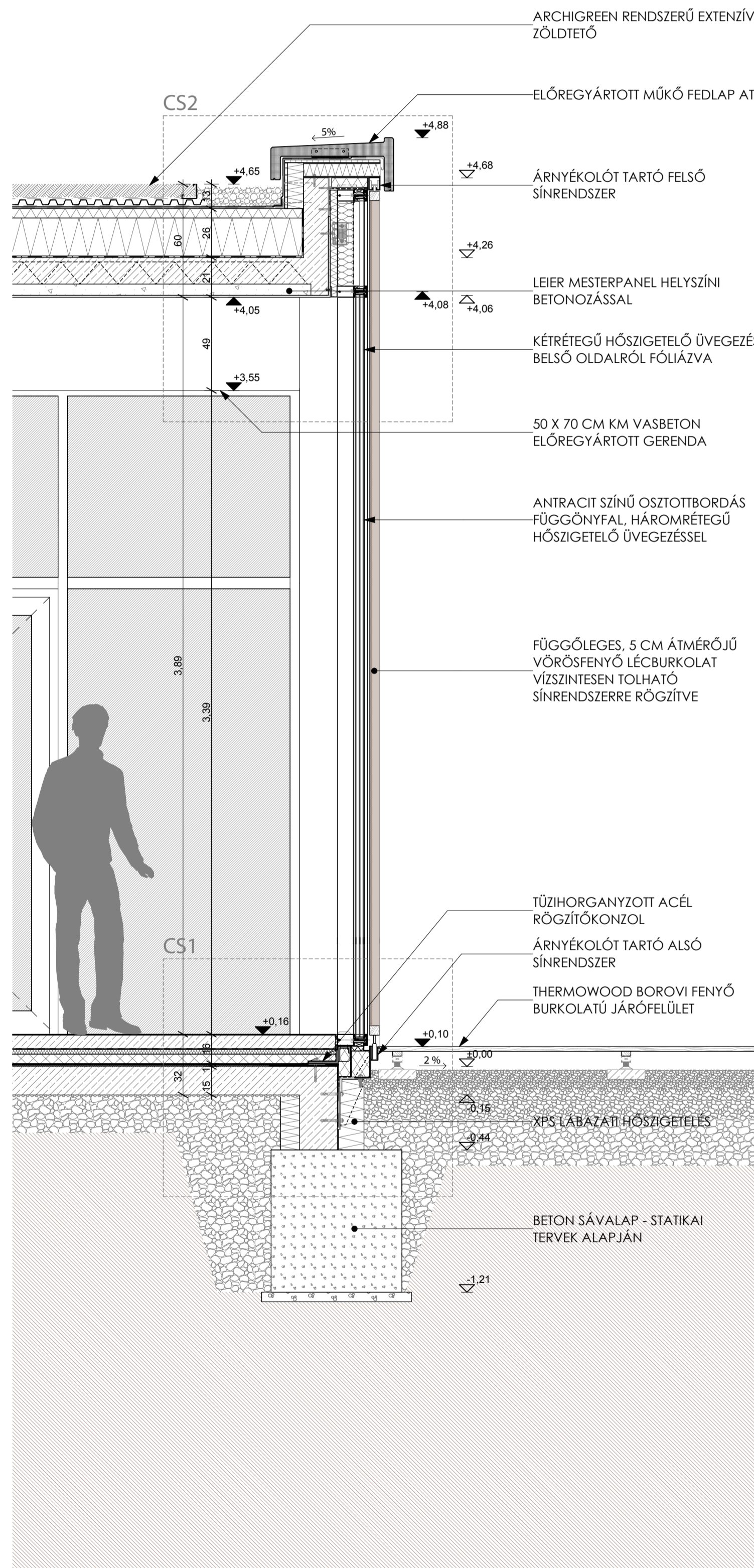

METSZET RÉSZLET 1:20

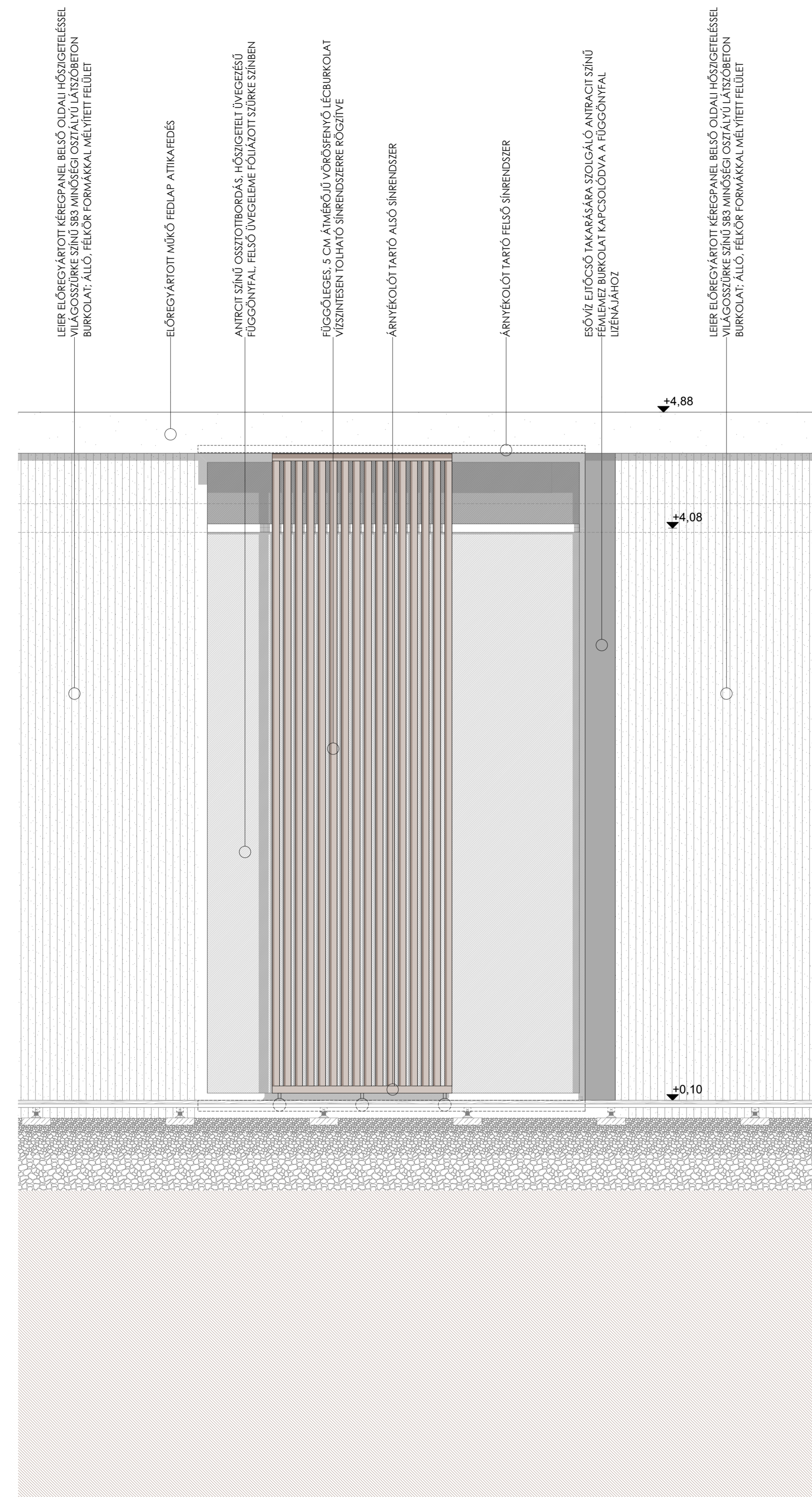

HOMLOKZATI RÉSZLET 1:20

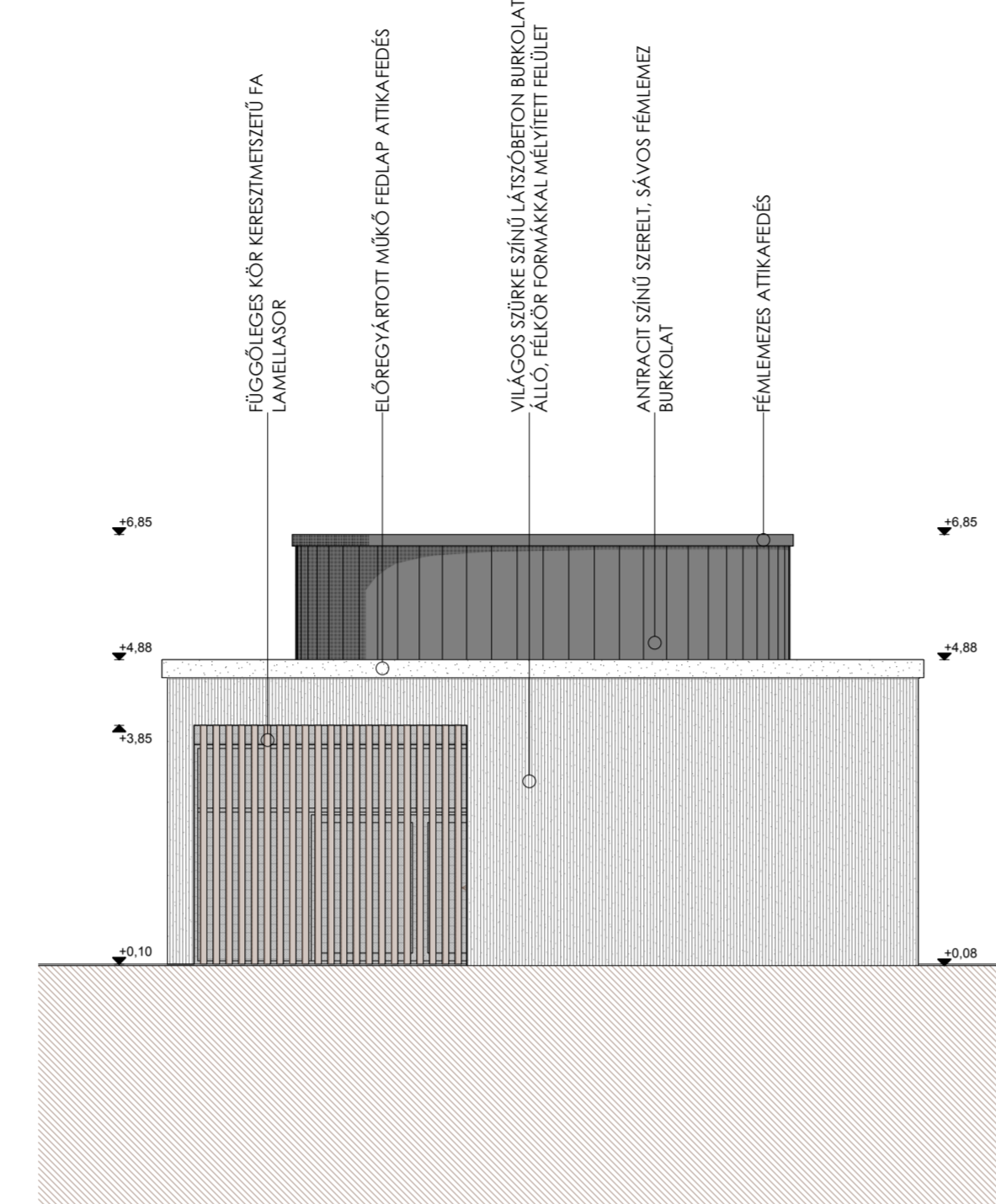

D-I HOMLOKZAT 1:100

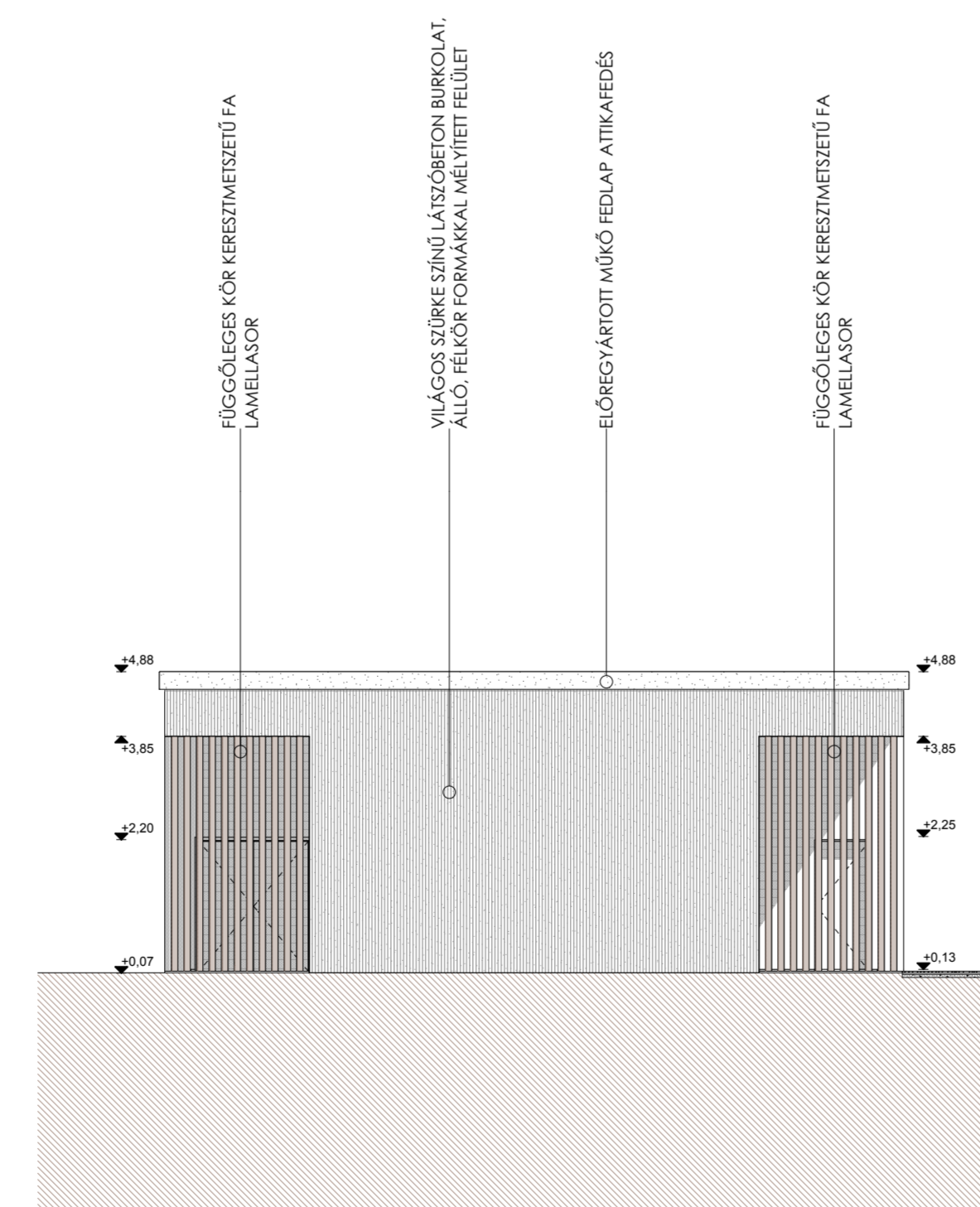

É-I HOMLOKZAT 1:100

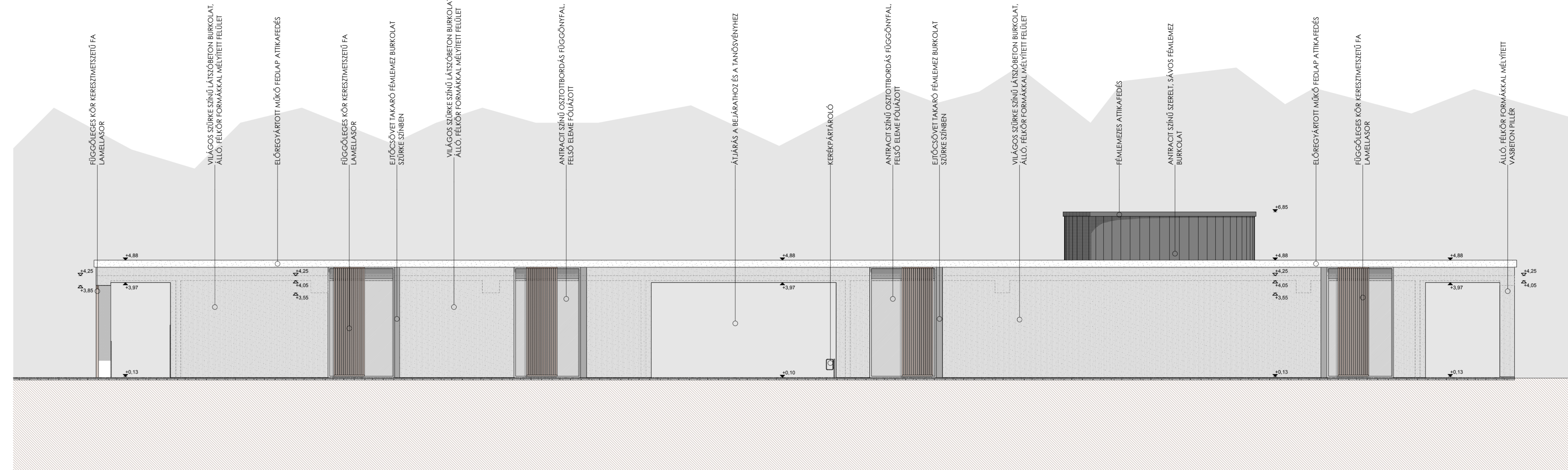

NY-I HOMLOKZAT 1:100

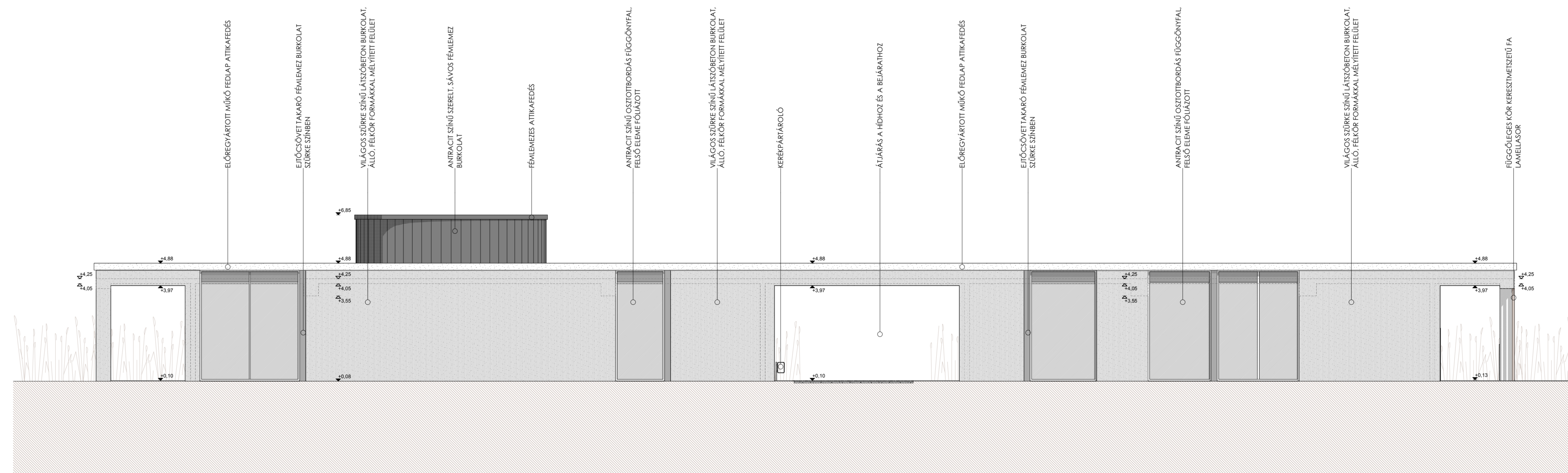

K-I HOMLOKZAT 1:100

